

Omniconverter[®] G/Sx Unmanaged 6 and 10 Port Ethernet Switch



User Manual

General and Copyright Notice

This publication is protected by U.S. and international copyright laws. All rights reserved. The whole or any part of this publication may not be reproduced, stored in a retrieval system, translated, transcribed, or transmitted, in any form, or by any means, manual, electric, electronic, electromagnetic, mechanical, chemical, optical or otherwise, without prior explicit written permission of Omnitron Systems Technology, Inc.

The following trademarks are owned by Omnitron Systems Technology, Inc.: FlexPoint[™], FlexSwitch[™], HybridNID[®], iConverter[®], miConverter[™], NetOutlook[®], OmniLight[®], OmniConverter[®], RuggedNet[®], Omnitron Systems Technology, Inc.[™], OST[™] and the Omnitron logo.

All other company or product names may be trademarks of their respective owners.

The information contained in this publication is subject to change without notice. Omnitron Systems Technology, Inc. is not responsible for any inadvertent errors.

Warranty

This network product and the included AC/DC power adapter are warranted to the original purchaser (Buyer) against defects in material and workmanship for a period of two (2) years from the date of shipment. The warranty for the network product (excluding the AC/DC power adapter) can be extended to five (5) years by registering the product at www.omnitron-systems.com/support within ninety (90) days from the date of shipment. During the warranty period, Omnitron will, at its option, repair or replace a product which is proven to be defective with the same product or with a product with at least the same functionality.

For warranty service, the product must be sent to an Omnitron designated facility, at Buyer's expense. Omnitron will pay the shipping charge to return the product to Buyer's designated US address using Omnitron's standard shipping method.

Limitation of Warranty

The foregoing warranty shall not apply to product malfunctions resulting from improper or inadequate use and/or maintenance of the equipment by Buyer, Buyer-supplied equipment, Buyer-supplied interfacing, unauthorized modifications or tampering with equipment (including removal of equipment cover by personnel not specifically authorized and certified by Omnitron), or misuse, or operating outside the environmental specification of the product (including but not limited to voltage, ambient temperature, radiation, unusual dust, etc.), or improper site preparation or maintenance.

No other warranty is expressed or implied. Omnitron specifically disclaims the implied warranties of merchantability and fitness for any particular purpose.

The remedies provided herein are the Buyer's sole and exclusive remedies. Omnitron shall not be liable for any direct, indirect, special, incidental, or consequential damages, whether based on contract, tort, or any legal theory.

Environmental Notices

The equipment covered by this manual must be disposed of or recycled in accordance with the Waste Electrical and Electronic Equipment Directive (WEEE Directive) of the European Community directive 2012/19/EU on waste electrical and electronic equipment (WEEE) which, together with the RoHS Directive 2015/863/EU, for electrical and electronic equipment sold in the EU after July 2019. Such disposal must follow national legislation for IT and Telecommunication equipment in accordance with the WEEE directive: (a) Do not dispose waste equipment with unsorted municipal and household waste. (b) Collect equipment waste separately. (c) Return equipment using collection method agreed with Omnitron.



The equipment is marked with the WEEE symbol shown to indicate that it must be collected separately from other types of waste. In case of small items the symbol may be printed only on the packaging or in the user manual. If you have questions regarding the correct disposal of equipment go to www.omnitron-systems.com/support or e-mail to Omnitron at intlinfo@omnitron-systems.com.

Safety Warnings and Cautions



ATTENTION: Observe precautions for handling electrostatic discharge sensitive devices.



WARNING: Potential damage to equipment and personal injury.



WARNING: Risk of electrical shock.

OmniConverter® G/Sx User Manual

Product Overview

The OmniConverter G/Sx is an unmanaged compact gigabit Ethernet switch that features copper or fiber uplink ports and four or eight 10/100/1000 RJ-45 copper user ports.

The G/Sx functions can be configured using easily accessible DIP-switches



OmniConverter G/Sx 6 and 10 Port Modules

Front Panel

The front of the G/Sx provides access to the RJ-45, SFP and Fixed-Fiber ports.

RJ-45, SFP and Fixed-Fiber Ports

The RJ-45 Ethernet user port supports 10BASE-T, 100BASE-TX and 1000BASE-T protocols, auto-negotiation, auto MDI/MDI-X crossover and can be manually forced to a specific speed and duplex mode.

The module is available with one or two gigabit SFP transceiver uplink ports or two 10/100/1000BASE-T RJ-45 copper uplink ports or two LC fixed gigabit fiber uplink ports.

The SFP ports support SERDES 1000BASE-X fiber transceivers (multimode, single-mode and single-mode single-fiber) and SGMII 10/100/1000BASE-T copper transceivers. The SFP interfaces operate in auto-negotiation and support full duplex operation.

Fixed-fiber 1000BASE-X connectors are available with multimode (MM) dual fiber, single-mode (SM) dual fiber and single-mode single-fiber (SF) options. Dual fiber options are available with ST, SC and LC connectors. Single-fiber options are available with SC connectors.

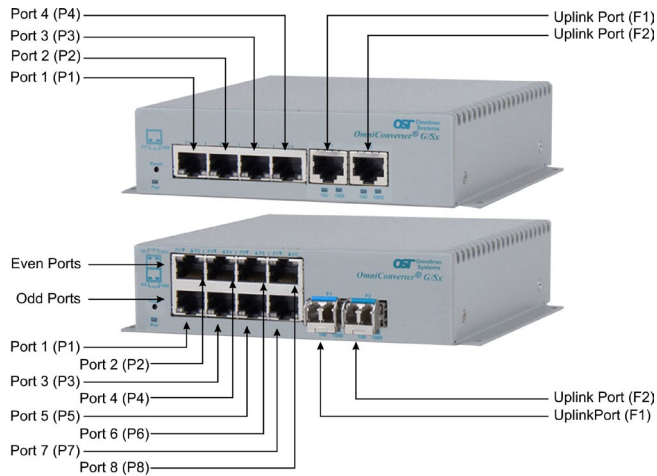

Front Panel Layout

Reset Button

A reset button is available on the front of the module to restore the module to factory default values and clearing buffers and memory. Press and hold the reset button for more than 5 seconds to restore the module to factory default values.

Installation Procedure

- 1) Configure DIP-switches
- 2) Installing the Module
- 3) Apply Power
- 4) Connect Cables
- 5) Verify Operation

1) Configure DIP-switches

DIP-switches are located on the side of the OmniConverter G/Sx. The DIP-switches are used to configure modes of operation and networking features.

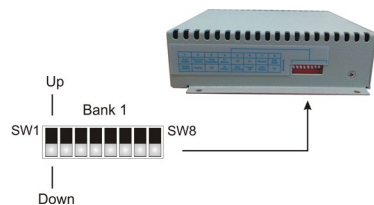

DIP-switch Bank Locations

The table below provides a description of each DIP-switch position and function.

Switch	1 Uplink Port	2 Uplink Ports
SW1	Mode of Operation	
SW2		
SW3	Reserved	Uplink Redundancy
SW4		
SW5	MAC Learning	
SW6	Pause	
SW7	L2CP	
SW8	Reserved	

DIP-switch Definitions

SW1 and SW2: Mode of Operation

The module supports Switch, Directed Switch and Dual Device modes.

The modes are described with MAC learning enabled. When MAC learning is disabled, unicast packets are forwarded to all ports.

SW1	SW2	1 Uplink Port	2 Uplink Ports
		Function	
DOWN	DOWN	Switch Mode (factory default)	
DOWN	UP	Directed Switch Mode (AKA Camera Mode)	
UP	DOWN	Reserved	Dual Device Mode - Switch Mode
UP	UP	Reserved	Dual Device Mode - Directed Switch Mode

Modes of Operation

Switch Mode

When configured for Switch Mode (factory default), the module operates as a standard layer 2 switch. Data flow will follow MAC address mapping.

Directed Switch Mode (AKA Camera Mode)

When configured for Directed Switch Mode, traffic from all the RJ-45 user ports is only forwarded to the uplink port F1, preventing the broadcast traffic from flooding other network ports. Incoming traffic from F1 follows MAC address mapping.

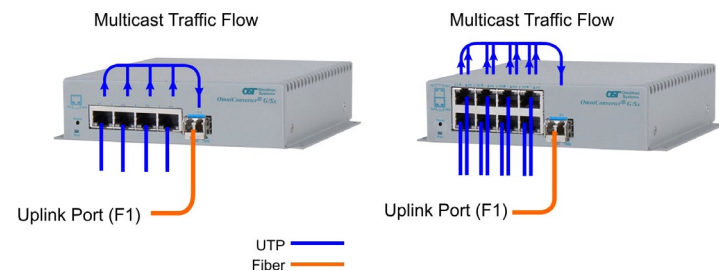

Directed Switch Mode Single Uplink Port

For models with two uplink ports (copper or fiber), the data traffic on the additional uplink port (F2) is also forwarded to port F1.

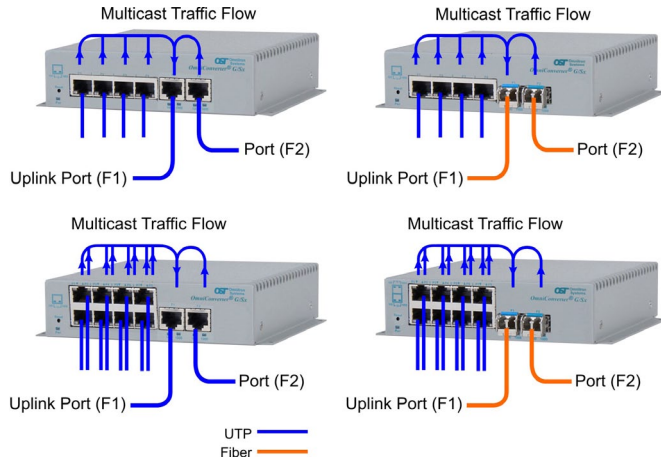

Directed Switch Mode Dual Uplink Port

When models with two uplink ports are configured for Directed Switch Mode and Uplink Redundancy (per DIP-switches 3 and 4), traffic is forwarded to both the primary and secondary uplink ports. The secondary port will block all traffic while the primary port is active. When the primary port goes down, the secondary port will be active and all traffic will be forwarded out the secondary port (F2).

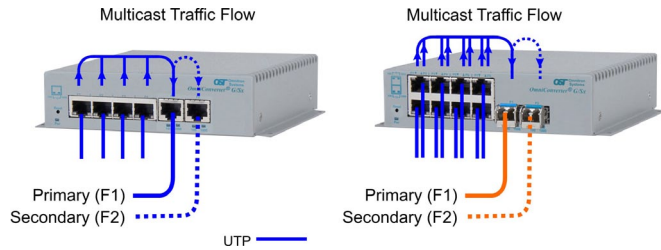

Directed Switch Mode with Uplink Redundancy

Dual Device Mode

Dual Device Mode is only supported on models with two uplink ports.

When configured for Dual Device Mode, the module is configured as two logically independent Layer 2 switches. On models with 4 RJ-45 user ports, Port F1 is associated with ports P1 and P2 and Port F2 is associated with ports P3 and P4. On models with 8 RJ-45 user ports, Port F1 is associated with ports P1 - P4 and Port F2 is associated with ports P5 - P8. Data flow will follow MAC address mapping.



Dual Device Mode

When models with 4 RJ-45 user ports are configured for Dual Device Mode and Directed Switch Mode, the traffic from ports P1 and P2 is only forwarded to uplink port F1 and ports P3 and P4 are only forwarded to uplink port F2. When models with 8 RJ-45 user ports are configured for Dual Device Mode and Directed Switch Mode, the traffic from ports P1 - P4 is only forwarded to uplink port F1 and ports P5 - P8 are only forwarded to uplink port F2. This prevents broadcast traffic from flooding other network ports. Incoming traffic from F1 and F2 follows MAC address mapping.

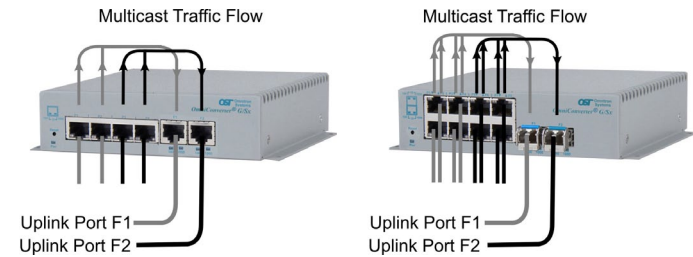

Dual Device with Directed Switch Mode

SW3 and SW4: Uplink Redundancy

Uplink redundancy mode is only supported on models with two uplink ports.

The modes are described with MAC learning enabled. When MAC learning is disabled, the module will send data to all ports.

SW3	SW4	1 Uplink Port	2 Uplink Ports
		Function	
DOWN	DOWN	Reserved	Switch Mode (factory default)
DOWN	UP	Reserved	Switch Mode (factory default)
UP	DOWN	Reserved	Uplink Redundancy Mode - no return to primary (F1)
UP	UP	Reserved	Uplink Redundancy Mode - return to primary (F1)

Uplink Redundancy

When configured for Uplink Redundant Mode “no return to primary”, the uplink ports operate as redundant links. A fault on the primary Port F1, will cause a fail over to the secondary Port F2 within 50msec. Port F1 will become the secondary port once the failure condition has been restored because “no return to primary” has been selected.

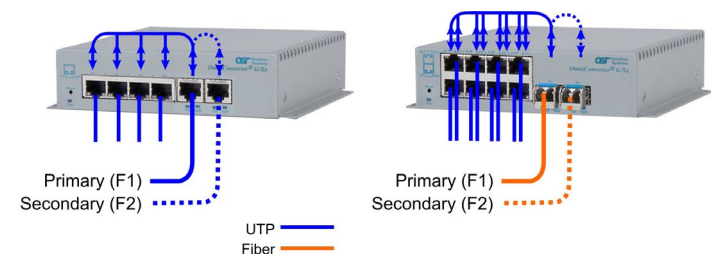

Redundant Uplink

When configured for Uplink Redundant Mode “return to primary’, a fault on the primary Port F1, will cause a fail over to the secondary Port F2 within 50msec. The module will return to the primary Port F1 after the failure condition has been restored for 6 seconds.

SW5: MAC Learning - “MAC Learning/Off”

When this DIP-switch is in the DOWN “MAC Learning” position (factory default), all ports on the module will learn the source MAC address of each received packet and store the address so packets destined for the stored addresses can be forwarded to the appropriate port on the module. When the DIP-switch is in the UP “Off” position, learning is turned off and all received unicast packets are forwarded to all ports.

SW6: Pause - “Pause Off/On”

Setting the DIP-switch to the DOWN “Pause Off” position (factory default) configures the module to advertise no Pause capability on all ports. Setting this DIP-switch to the UP “On” position configures the module to advertise Symmetrical and Asymmetrical Pause capability to all ports.

SW7: L2CP - “L2CP Tunnel/Discard”

When this DIP-switch is in the DOWN “L2CP Tunnel” position (factory default), all L2CP frames will be tunneled through the module. When this DIP-switch is in the UP “Discard” position, all L2CP frames will be discarded with the exception of the frames listed below.

Multicast Destination Address	Name	SW7 L2CP DOWN / UP
01-80-C2-00-00-00	Bridge Group Address	Tunnel
01-80-C2-00-00-01	IEEE Std 802.3 Full Duplex PAUSE	Based on PAUSE
01-80-C2-00-00-0B	Reserved for future standardization	Tunnel
01-80-C2-00-00-0C	Reserved for future standardization	Tunnel
01-80-C2-00-00-0D	Provider Bridge GVRP Address	Tunnel
01-80-C2-00-00-0F	Reserved for future standardization	Tunnel
01-80-C2-00-00-10	All Bridges	Tunnel
01-80-C2-00-00-2X	GARP	Tunnel
01-80-C2-00-00-3X	802.1ag CFM	Tunnel

If SW6 is in the DOWN “Pause Off” position, all PAUSE frames are TUNNELED. If SW6 is in the UP “On” position, the module is participating in the PAUSE function.

SW8: Reserved

2) Installing the Module

Wall Mounting

The wall mounting height of the module should be less than or equal to 2 meters (6.6 feet) from the floor. Use the four mounting holes on the module to secure the module to the wall. The module can accommodate #6 screws (not included).

Installation of the module should be such that the air flow in the front, back, side and top vents of the switch are not compromised or restricted.

The accessory cables should have their own strain relief and do not pull down on the module.

Rack Mounting

The module can be rack mounted using the optional Rack Mount Shelf (8260-0). Refer to the Rack Mount Shelf user manual (040-08260-001x) for the proper installation guidelines.

Follow the same guidelines above when rack mounting the module.

3) Apply Power

AC Power

Secure the ground wire to the ground screw. See the figure below for the location of the grounding screws.

Route the power cord through the provided strain relief for additional support and connect the barrel connector at the end of the wire on the AC/DC adapter to the barrel connector on the module. Connect the AC/DC adapter to the AC outlet. Confirm that the module has powered up properly by checking the Power LED located on the front of the switch.

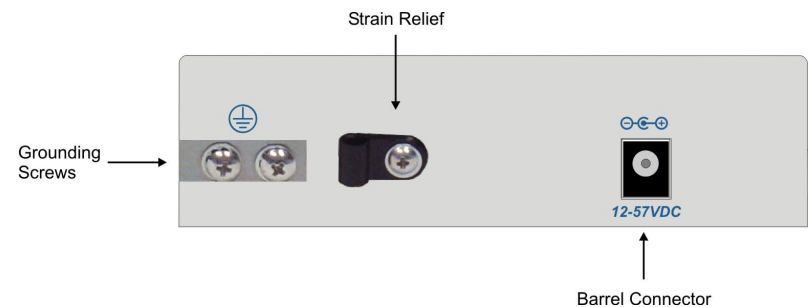

AC Models Rear View: Barrel Connector for AC/DC Power Adapter

WARNING!!!
 NEVER ATTEMPT TO OPEN THE CHASSIS OR SERVICE THE POWER SUPPLY. OPENING THE CHASSIS MAY CAUSE SERIOUS INJURY OR DEATH. THERE ARE NO USER REPLACEABLE OR SERVICEABLE PARTS IN THIS UNIT.

DC Power

This module is intended for installation in restricted access areas. (“Les matériels sont destinés à être installés dans des EMBLEMES À ACCÈS RESTREINT”). A restricted access area can be accessed only through the use of a special key, or other means of security.

The over current protection for connection with centralized DC shall be provided in the building installation, and shall be a UL listed circuit breaker rated 20 Amps, and installed per the National Electrical Code, ANSI/NFPA-70.

Appropriate overloading protection should be provided on the DC power source outlets utilized.

The 6 Port G/Sx requires +12 to +57VDC inclusive of tolerances (0.68A @ 12VDC max rated power). The 10 Port G/M requires +12 to +57VDC inclusive of tolerances (0.75A @ 12VDC max rated power). See specification table for specific model requirements.

Appropriate overloading protection should be provided on the DC power source outlets utilized.

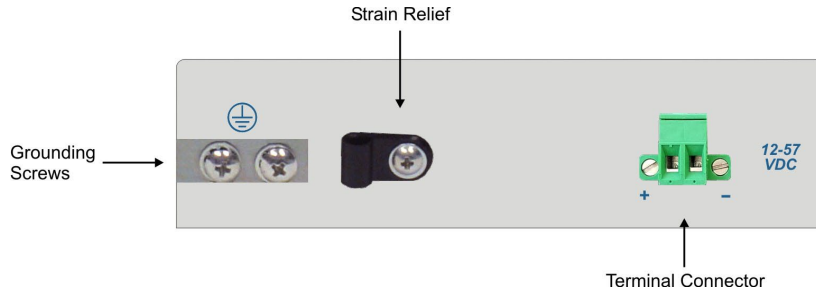

DC Models Rear View: 2-Pin Terminal for DC Power

WARNING: Only a DC power source that complies with safety extra low voltage (SELV) requirements can be connected to the DC-input power supply.

WARNING REGARDING EARTHING GROUND:

- This equipment shall be connected to the DC supply system earthing electrode conductor or to a bonding jumper from an earthing terminal bar or bus to which the DC supply system earthing electrode is connected.
- This equipment shall be located in the same immediate area (such as adjacent cabinets) as any other equipment that has a connection between the earthed conductor of the same DC supply circuit and the earthing conductor, and also the point of earthing of the DC system. The DC system shall not be earthed elsewhere.
- The DC supply source is to be located within the same premises as this equipment.
- There shall be no switching or disconnecting devices in the earthed circuit conductor between the DC source and the earthing electrode conductor.

Locate the DC circuit breaker of the external power source, and switch the circuit breaker to the OFF position.

Prepare a power cable using a three conductor insulated wire (not supplied) with 12AWG to 14AWG thickness. Cut the power cable to the length required.

Strip approximately 3/8 of an inch of insulation from the power cable wires.

Connect the ground wire to the grounding screws on the back of the module.

Connect the power cables to the module by fastening the stripped ends to the DC power connector.

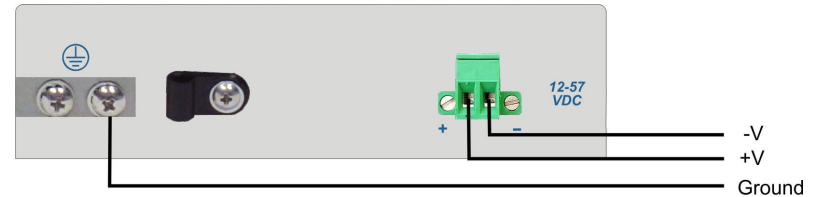

DC Models Rear View: Power Connections

WARNING: The positive lead of the power source must be connected to the “+” terminal on the module and the negative lead of the power source to the “-” terminal on the module as shown above.

The power connections on the module are isolated. This provides support of positive or negative power connections.

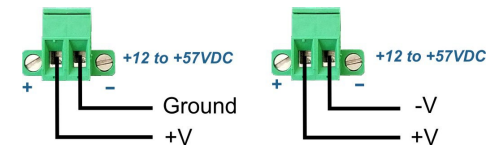

Power Options

WARNING: Note the wire colors used in making the positive, negative and ground connections. Use the same color assignment for the connection at the circuit breaker.

Connect the power wires to the circuit breaker and switch the circuit breaker ON. If any module are installed, the Power LED will indicate the presence of power.

During the installation, ensure that the ground potentials are maintained throughout the system connections. This includes but not limited to the power source ground and any shielded cabling grounds.

WARNING!!!

NEVER ATTEMPT TO OPEN THE CHASSIS OR SERVICE THE POWER SUPPLY. OPENING THE CHASSIS MAY CAUSE SERIOUS INJURY OR DEATH. THERE ARE NO USER REPLACEABLE OR SERVICEABLE PARTS IN THIS UNIT.

Make sure to disconnect the power and ground cables before removing the equipment.

4) Connect Cables

- a. When using SFP models, insert the SFP fiber transceiver into the SFP receptacle on the front of the module (see the SFP Data Sheet 091-17000-001 for supported Gigabit transceivers).

NOTE: The release latch of the SFP fiber transceiver must be in the closed (up) position before insertion.

- b. Connect an appropriate multimode or single-mode fiber cable to the fiber port on the front of the module. It is important to ensure that the transmit (TX) is attached to the receive side of the transceiver at the other end and the receive (RX) is attached to the transmit side. When using single-fiber (SF) models, the TX wavelength must match the RX wavelength at the other end and the RX wavelength must match the TX wavelength at the other end.
- c. Connect the Ethernet 10/100/1000 RJ-45 port using a Category 5 or better cable to an external 10BASE-T, 100BASE-TX or 1000BASE-T Ethernet device.

5) Verify Operation

Verify the module is operational by viewing the LED indicators.

Power LED Indicators		
Legend	Indicator	Description
Pwr	OFF	Unit not powered
	Green - ON	Unit powered
	Amber - ON	Input voltage below or above nominal range
	Green - Blinking at 1Hz	Indicates reset button has been pressed for more than 5 seconds and the module is ready to be restored to factory default values

Power LED Indicators

Fiber Ports LED Indicators - Fixed Fiber Models		
Legend	Indicator	Description
1000	OFF	No link
	Green - ON	Port linked at 1000Mbps
	Green - Blinking at 10Hz	Port data activity at 1000Mbps
	Green - Blinking at 1Hz	Port linked at 1000Mbps and in redundant standby mode
	Amber - Blinking at 1Hz	Port linked at 1000Mbps and receiving AN Remote Fault

Fiber LED Indicators - Fixed Fiber Models

Uplink Ports LED Indicators - SFP and Copper Uplink Models		
Legend	Indicator	Description
100	OFF	No link
	Green - ON	Port linked at 100Mbps
	Green - Blinking at 10Hz	Port data activity at 100Mbps
	Green - Blinking at 1Hz	Port linked at 100Mbps and in redundant standby mode
	Amber - Blinking at 1Hz	Port linked at 100Mbps and receiving Far End Fault Indicator (FEFI)
1000	OFF	No link
	Green - ON	Port linked at 1000Mbps
	Green - Blinking at 10Hz	Port data activity at 1000Mbps
	Green - Blinking at 1Hz	Port linked at 1000Mbps and in redundant standby mode
	Amber - Blinking at 1Hz	Port linked at 1000Mbps and receiving AN Remote Fault

Uplink LED Indicators - SFP and Copper Models

RJ-45 User Ports LED Indicators		
Legend	Indicator	Description
100	OFF	No link
	Green - ON	Port linked at 100Mbps
	Green - Blinking at 10Hz	Port data activity at 100Mbps
	Amber -ON	Port linked at 100Mbps Half-duplex
	Amber - Blinking at 10Hz	Port data activity at 100Mbps Half-duplex
1000	OFF	No link
	Green - ON	Port linked at 1000Mbps
	Green - Blinking at 10Hz	Port data activity at 1000Mbps
	Amber -ON	Port linked at 1000Mbps Half-duplex
	Amber - Blinking at 10Hz	Port data activity at 1000Mbps Half-duplex
10 (100+1000)	OFF	No link
	Green - ON	Port linked at 10Mbps
	Green - Blinking at 10Hz	Port data activity at 10Mbps
	Amber -ON	Port linked at 10Mbps Half-duplex
	Amber - Blinking at 10Hz	Port data activity at 10Mbps Half-duplex

RJ-45 LED Indicators

Specifications

Description	OmniConverter® G/Sx 10/100/1000BASE-T with Gigabit Fiber or Copper Uplinks Unmanaged 6 or 10 Port Gigabit Ethernet Switch	
Standard Compliances	IEEE 802.3	
Environmental	REACH, RoHS, WEEE	
Frame Size	Up to 10,240 bytes	
Port Types	Copper: 10/100/1000BASE-T (RJ-45) Fiber: Fixed: ST, SC, LC 1000BASE-X Fiber SFP: 10/100/1000BASE-T SGMII Copper Transceiver or 1000BASE-X Fiber Transceiver	
Cable Types	Copper: EIA/TIA 568A/B, Cat 5 UTP and higher Fiber: Multimode: 50/125, 62.5/125µm Single-mode: 9/125µm	
AC Power Requirements (Models with AC/DC Adapters)	100 - 240VAC 50/60Hz 0.2A max at 115VAC 0.1A max at 230VAC	
DC Power Requirements (Models with DC Terminals)	4 RJ-45 Ports: +12 to +57VDC; inclusive of tolerance 0.68A @ 12VDC 0.17A @ 48VDC 2 Pin Terminal (non-isolated)	8 RJ-45 Ports: +12 to +57VDC; inclusive of tolerance 0.75A @ 12VDC 0.19A @ 48VDC 2 Pin Terminal (non-isolated)
Dimensions (W x D x H)	6.28" x 5.2" x 1.5" (159.5 mm x 132.1 mm x 38.1 mm)	
Weight	4 RJ-45 Ports: Module Only: 1.5 lb.; 720 grams Module with AC/DC Adapter: 2.0 lbs.; 913 grams	8 RJ-45 Ports: Module Only: 1.6 lbs.; 748 grams Module with AC/DC Adapter: 2.1 lbs.; 941 grams
Operating Temperature	Commercial: 0 to 50°C Wide: -40 to 60°C (-20°C AC cold start) Extended: -40 to 75°C (-20°C AC cold start) Storage: -40 to 80°C	
Humidity	5 to 95% (non-condensing)	
Altitude	-100m to 4,000m (operational)	
MTBF (hours)	Module Only: 309,000 Module with AC/DC Adapter: 100,000	
Warranty	5 year product warranty with 24/7/365 free Technical Support 2 year AC power adapter warranty	

Regulatory Compliances	Safety:	UL 62368-1, UL 60950-1, IEC 62368-1, IEC 60950-1, EN 62368-1, EN 60950-1, CAN/CSA C22.2 No. 62368-1-14, CAN/CSA C22.2 No. 60950-1, CE Mark, UKCA
	EMC:	EN 55032/24 CE Emissions/Immunity, IEC 61000-6-4 Industrial Emissions, IEC 61000-6-2 Industrial Immunity
	EMI:	CISPR 32, FCC 47 Part 15 Subpart B Class A
	EMS:	IEC 61000-4-2 ESD: Contact: 6 kV; Air: 8 kV, IEC 61000-4-3 RS: 80 MHz to 1 GHz: 10 V/m, IEC 61000-4-4 EFT: Power: 2 kV; Signal: 1 kV (DC models), IEC 61000-4-4 EFT: Power: 1 kV; Signal: 1 kV (AC models), IEC 61000-4-5 Surge: Power: 2 kV; Signal: 2 kV (DC models), IEC 61000-4-5 Surge: Power: 1 kV Line/Line; 2 kV Line/Gnd; Signal: 2 kV (AC models), IEC 61000-4-6 CS: Signal: 10 V, IEC 61000-4-8 (Magnetic Field) 30A/m, IEC 61000-4-11 (Voltage Dips, interrupts)
	IP Rating:	IP20 Protection
	Act:	TAA, BAA, NDAA

Customer Support Information

If you encounter problems while installing this product, contact Omnitron Technical Support:

Phone: (949) 250-6510

Fax: (949) 250-6514

Address: Omnitron Systems Technology, Inc.

38 Tesla

Irvine, CA 92618, USA

Email: support@omnitron-systems.com

URL: www.omnitron-systems.com